



Cambridge International Examinations
Cambridge International General Certificate of Secondary Education

PHYSICS

0625/14

Paper 1 Multiple Choice

May/June 2015

45 minutes

Additional Materials: Multiple Choice Answer Sheet
Soft clean eraser
Soft pencil (type B or HB recommended)

* 3 6 4 7 4 5 0 8 3 2 *

READ THESE INSTRUCTIONS FIRST

Write in soft pencil.

Do not use staples, paper clips, glue or correction fluid.

Write your name, Centre number and candidate number on the Answer Sheet in the spaces provided unless this has been done for you.

DO NOT WRITE IN ANY BARCODES.

There are **forty** questions on this paper. Answer **all** questions. For each question there are four possible answers **A, B, C** and **D**.

Choose the **one** you consider correct and record your choice in **soft pencil** on the separate Answer Sheet.

Read the instructions on the Answer Sheet very carefully.

Each correct answer will score one mark. A mark will not be deducted for a wrong answer.

Any rough working should be done in this booklet.

Electronic calculators may be used.

The syllabus is approved for use in England, Wales and Northern Ireland as a Cambridge International Level 1/Level 2 Certificate.

This document consists of **18** printed pages and **2** blank pages.

1 The diagram shows a measuring instrument.

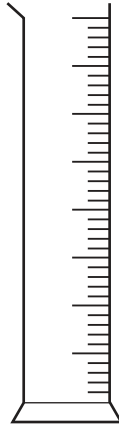

Which quantity is this instrument used to measure?

- A area
- B density
- C mass
- D volume

2 The diagram shows the distance-time graph of an object.

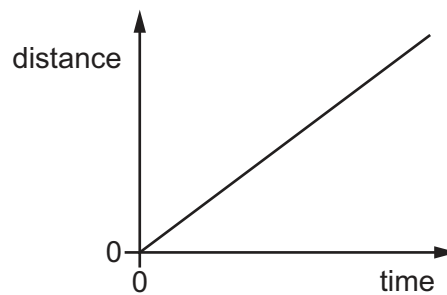

Which statement describes the object?

- A It is accelerating.
- B It is moving at a constant speed.
- C It is slowing down.
- D It is stationary.

- 3 A tennis player hits a ball hard and 0.40 s later hears the echo from a wall.



The speed of sound in air is 330 m/s.

How far away is the player from the wall?

- A 66 m B 132 m C 264 m D 825 m
- 4 Weight is an example of which quantity?
- A acceleration
B force
C mass
D pressure
- 5 Which substance in the table has the lowest density?

	substance	mass / g	volume / cm ³
A	nylon	1.2	1.0
B	cotton	1.5	1.0
C	olive oil	1.8	2.0
D	water	2.0	2.0

- 6 A car travels along a horizontal road at a constant speed. Three horizontal forces act on the car. The diagram shows two of these three forces.

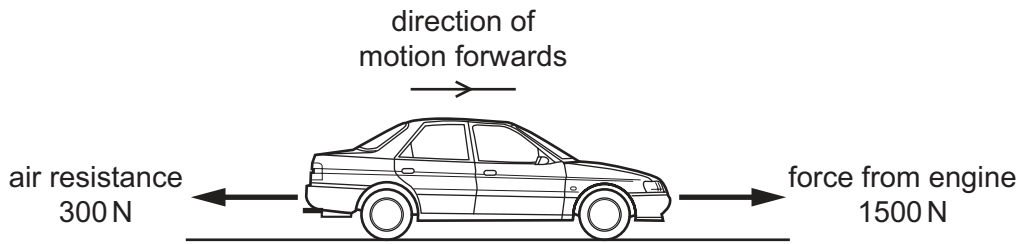

What is the size and the direction of the third horizontal force acting on the car?

- A 1200 N backwards
 B 1200 N forwards
 C 1800 N backwards
 D 1800 N forwards
- 7 The extension-load graph for a spring is shown. The unstretched length of the spring is 17.0 cm.

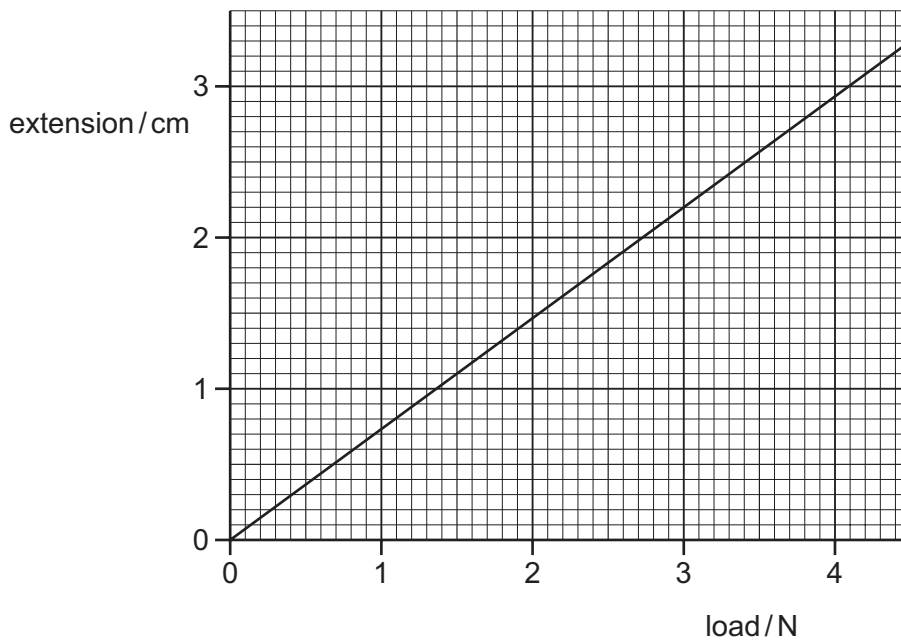

When an object is hung from the spring, the length of the spring is 19.2 cm.

What is the weight of the object?

- A 1.4 N B 1.6 N C 2.6 N D 3.0 N

- 8 Which form of energy is used to generate electrical energy in a tidal power station?
- A chemical energy
 B gravitational energy
 C internal energy (thermal energy)
 D nuclear energy
- 9 Four different model steam engines each lift a 1.0 kg object from the **same** laboratory floor to the **same** laboratory bench. Each engine takes a different time to lift the object.

How does the most powerful engine compare with the other engines?

	speed of lifting object onto bench	useful work done
A	faster	more than other engines
B	faster	same as other engines
C	slower	less than other engines
D	slower	same as other engines

- 10 Which statement is explained by reference to pressure?
- A Objects with greater mass have greater weight.
 B One kilogram of water occupies more volume than one kilogram of lead.
 C Spikes on running-shoes sink into the ground.
 D Water cooled to a low enough temperature turns to ice.
- 11 Small smoke particles suspended in air are viewed through a microscope.

The smoke particles move randomly.

What does this show?

- A The air consists of fast-moving molecules.
 B The pressure of the air is increasing.
 C There are convection currents in the air.
 D The temperature of the air is increasing.

12 The gas in a container is heated but is kept at constant volume.

Why does the gas pressure increase?

- A The molecules expand.
- B The molecules increase in mass.
- C The molecules move further apart.
- D The molecules move more rapidly.

13 Which row is correct for the evaporation of a liquid?

	the particles escaping from the liquid are on average	the average kinetic energy of particles remaining in the liquid
A	the least energetic	decreases
B	the least energetic	increases
C	the most energetic	decreases
D	the most energetic	increases

14 A long thin bar of copper is heated evenly along its length.

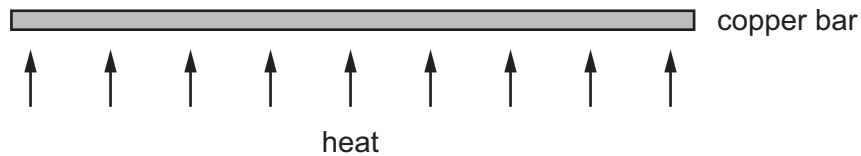

What happens to the bar?

- A It becomes less heavy.
- B It becomes longer.
- C It becomes shorter.
- D It bends at the ends.

- 15 A solid is heated from room temperature. The graph shows how its temperature changes with time as it is heated constantly.

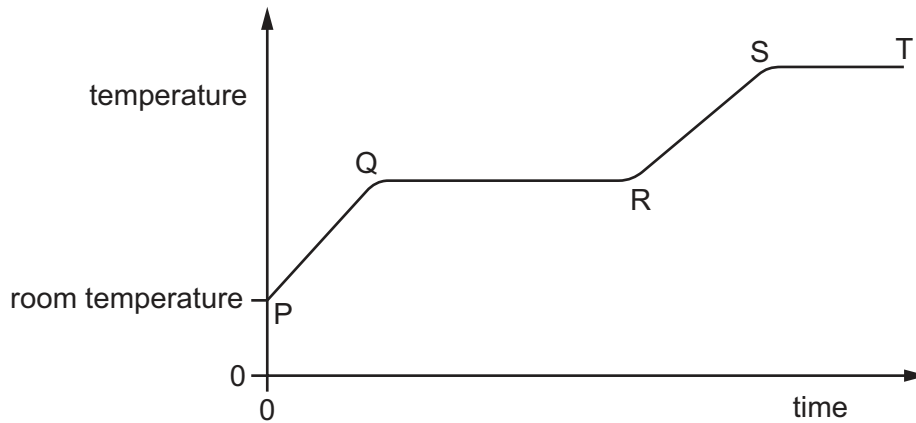

Between which labelled points on the graph is the substance partly solid and partly liquid?

- A between P and Q
 - B between Q and R
 - C between R and S
 - D between S and T
- 16 One method of heat transfer involves the energy travelling at a much greater speed than in other methods.

What is the name of this method?

- A conduction
- B convection
- C evaporation
- D radiation

17 The diagram shows four markings on a liquid-in-glass thermometer.

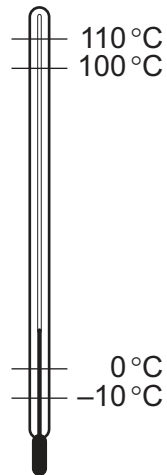

Which temperatures are the upper and lower fixed points?

	upper fixed point/ $^{\circ}\text{C}$	lower fixed point/ $^{\circ}\text{C}$
A	110	0
B	110	-10
C	100	0
D	100	-10

18 The diagram shows a block of ice placed in a warm room.

At which point is the temperature the **lowest**?

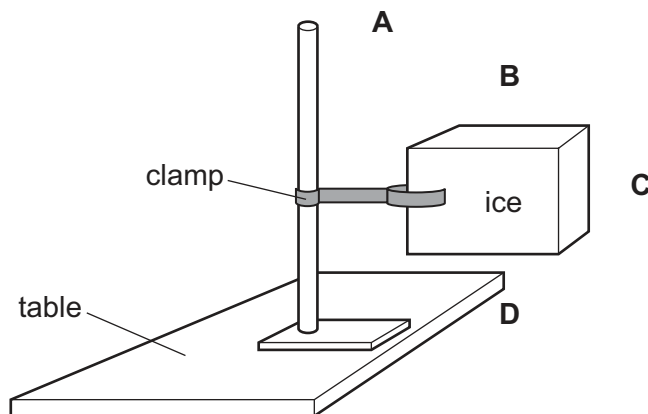

19 The thermal capacity of solid Y is greater than that of solid Z.

What is a consequence of this?

- A Solid Y needs less thermal energy to melt it than solid Z.
- B Solid Y needs less thermal energy to raise its temperature by 1°C than solid Z.
- C Solid Y needs more thermal energy to melt it than solid Z.
- D Solid Y needs more thermal energy to raise its temperature by 1°C than solid Z.

20 The diagram shows a water wave in a ripple tank.

Which line represents a wavefront?

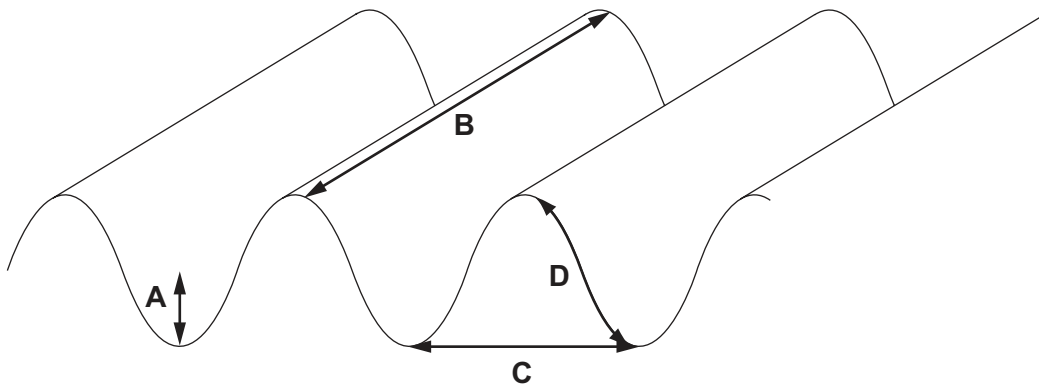

21 Which diagram shows how the light from a candle is reflected by a mirror, and shows the position of the image formed?

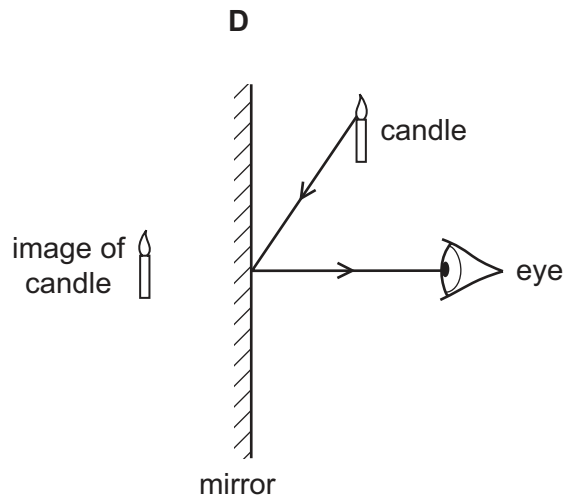
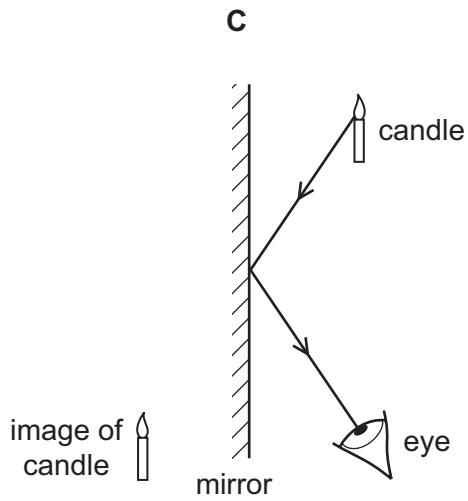
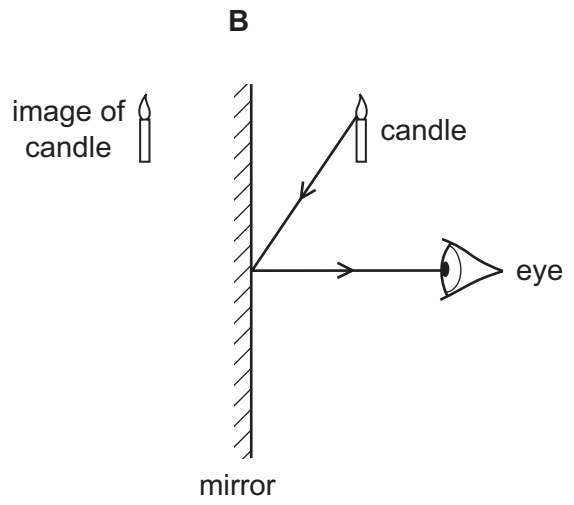
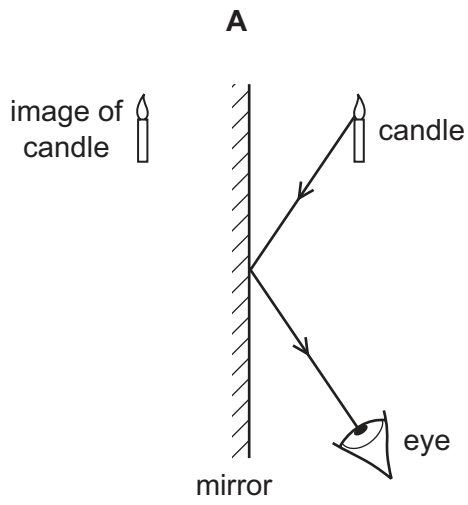

- 22 The diagram shows a ray of white light incident on a triangular glass prism.

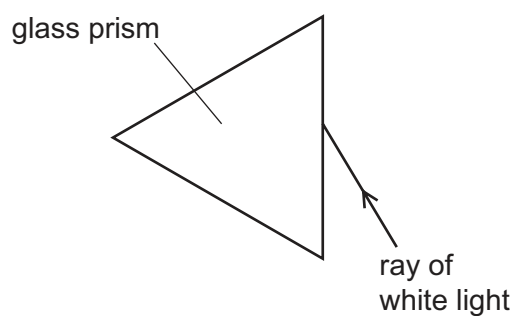

The ray enters the prism.

Which row correctly states if the light is refracted, and if the light is dispersed?

	refracted	dispersed
A	no	no
B	no	yes
C	yes	no
D	yes	yes

- 23 A parallel beam of light falls on a converging lens.

Which diagram shows what happens to the beam of light?

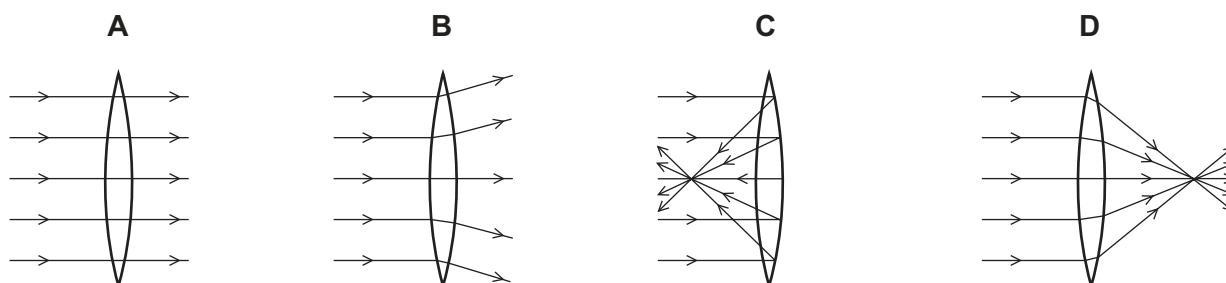

- 24 In the experiment shown, the bell is heard ringing. The air is gradually pumped out of the jar. No change is made to the ringing bell.

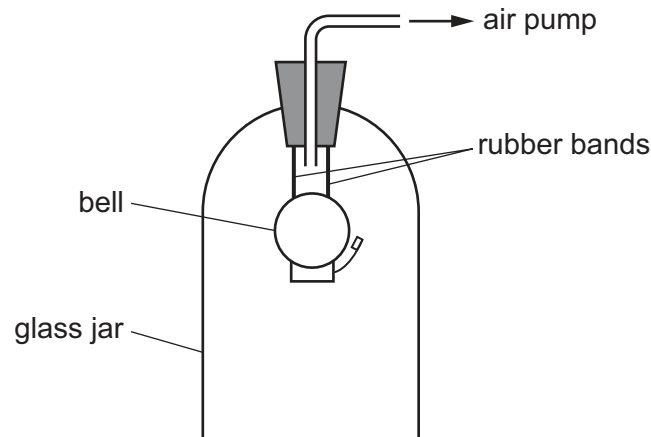

After a few minutes the bell can no longer be heard.

Why is this?

- A The amplitude of vibration of the bell decreases.
 - B The frequency of vibration of the bell increases.
 - C The sound waves from the bell become transverse.
 - D The sound waves need a medium to travel through.
- 25 What can be heard by the human ear?
- A a whistle emitting a wave of frequency 50 kHz
 - B a bat emitting a wave of frequency 30 kHz
 - C an insect emitting a wave of frequency 300 Hz
 - D a vibrating spring emitting a wave of frequency 5 Hz
- 26 Which action will demagnetise a magnetised piece of steel?
- A Cool it in a freezer for several hours.
 - B Hit it repeatedly with a hammer.
 - C Put it in a coil carrying a direct current (d.c.).
 - D Put it near an unmagnetised piece of iron.

- 27 Which row gives the unit for electromotive force (e.m.f.) and the unit for potential difference (p.d.)?

	electromotive force	potential difference
A	newton	joule
B	newton	volt
C	volt	joule
D	volt	volt

- 28 A student investigates the force on a bar magnet placed near a current-carrying coil. She carries out three different experiments.

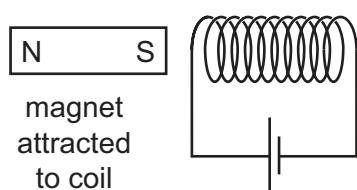

experiment 1

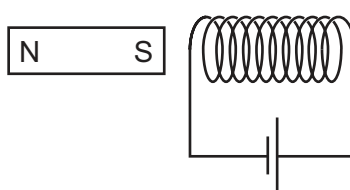

experiment 2

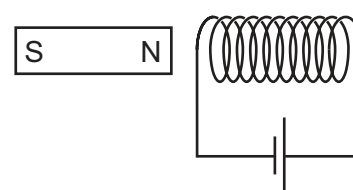

experiment 3

In experiment 1, the magnet is attracted to the coil.

Which row shows what happens in the other two experiments?

	experiment 2	experiment 3
A	magnet attracted	magnet attracted
B	magnet attracted	magnet repelled
C	magnet repelled	magnet attracted
D	magnet repelled	magnet repelled

- 29 Which sample of copper wire has the greatest electrical resistance?

	length of wire / m	diameter of wire / mm
A	1.0	2.0
B	1.0	4.0
C	10	2.0
D	10	4.0

- 30 A student uses the circuit shown to determine the resistance of the two identical resistors.

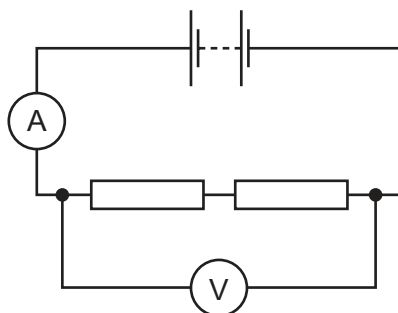

The voltmeter reading is 2.2 V and the ammeter reading is 0.25 A.

What is the resistance of each resistor?

- A** 0.275 Ω **B** 0.55 Ω **C** 4.4 Ω **D** 8.8 Ω
- 31 Which component is represented by this circuit symbol?

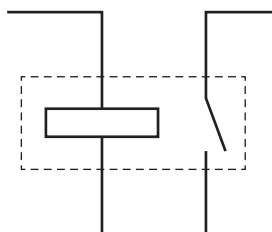

- A** a bell
B a fuse
C a relay
D a transformer
- 32 A student sets up this circuit.

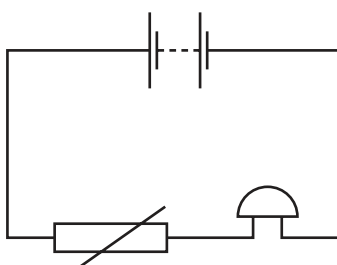

What is the purpose of the circuit?

- A** to allow a lamp to be made dimmer or brighter as required
B to amplify the sound of a voice
C to light a lamp in the dark
D to sound a bell when the temperature rises

33 Three cores of different metals, P, Q and R, are placed inside identical coils of wire.

At least one of the metals is non-ferrous.

The cores are held above some iron nails.

The three diagrams below show what happens when there is a current in the coils.

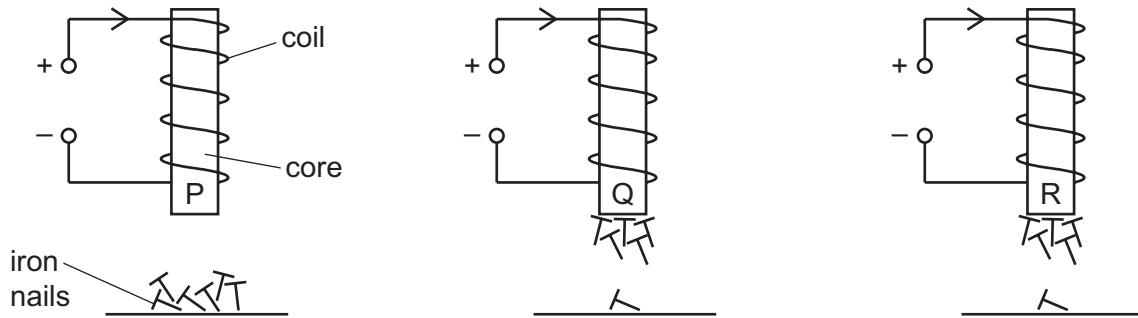

The three diagrams below show what happens when the current is then switched off.

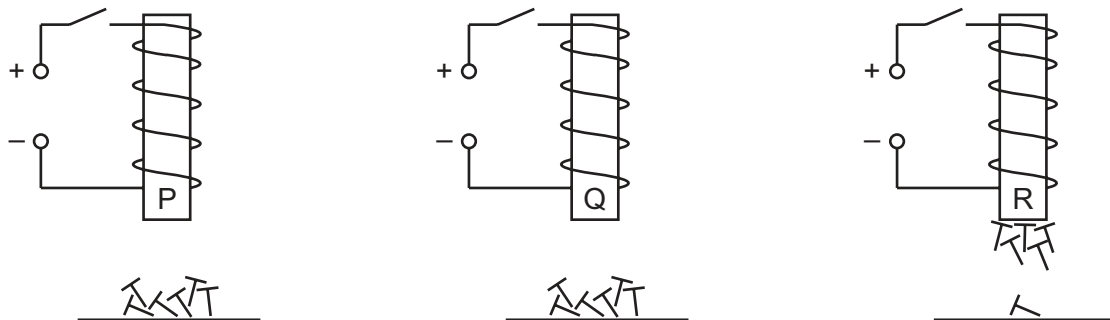

Which row identifies whether the core metals are ferrous or non-ferrous?

	ferrous	non-ferrous
A	P	Q and R
B	P and Q	R
C	Q and R	P
D	R	P and Q

34 Which diagram represents the voltage output of a simple a.c. generator?

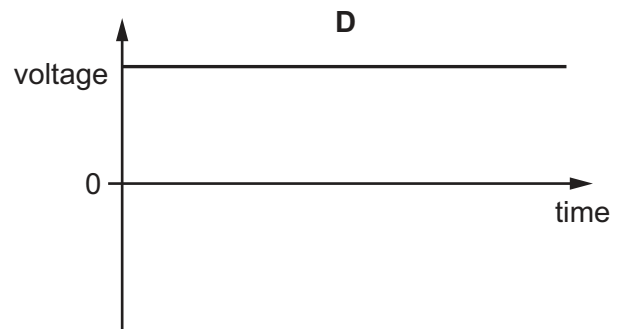
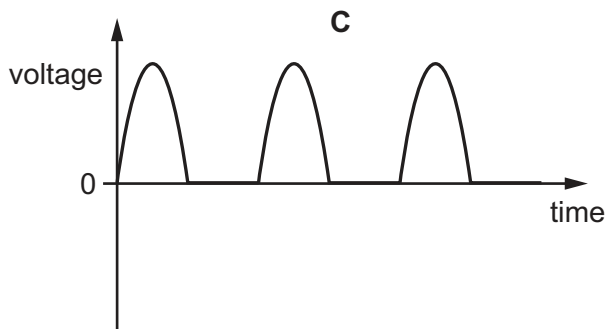
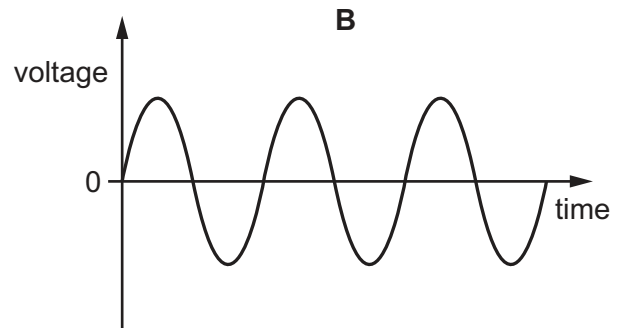
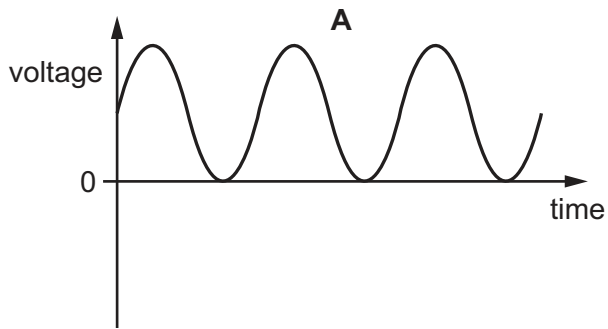

35 In an electrical circuit, what is the purpose of a fuse?

- A** to connect the metal case of an appliance to the earth
- B** to cut off the electrical supply if the current is too large
- C** to keep an electrical appliance dry in damp conditions
- D** to maintain a steady voltage as the current varies

36 The diagram shows a cathode-ray tube.

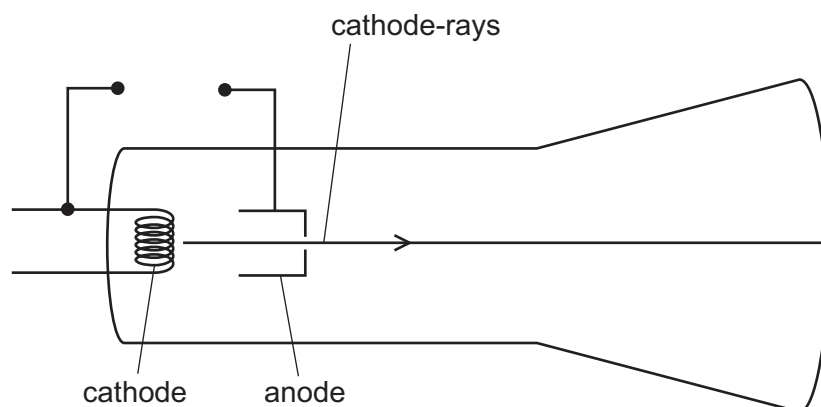

Which electrode should be heated, and which electrode should be positive?

	heated electrode	positive electrode
A	anode	anode
B	anode	cathode
C	cathode	anode
D	cathode	cathode

37 Which particles are emitted during thermionic emission?

- A** atoms
- B** electrons
- C** neutrons
- D** protons

38 A uranium ${}_{92}^{238}\text{U}$ nucleus emits an α -particle.

What are the new nucleon and proton numbers?

	nucleon number	proton number
A	238	88
B	236	90
C	234	92
D	234	90

39 Which row shows the nature and the penetrating ability of β -particles?

	nature	most are stopped by
A	electron	a few mm of aluminium
B	electron	a thin sheet of paper
C	helium nucleus	a few mm of aluminium
D	helium nucleus	a thin sheet of paper

40 A radioactive isotope is placed near a detector. The readings on the detector are corrected for background radiation and recorded every hour.

The table shows the corrected readings.

time / hours	0	1.0	2.0	3.0	4.0
count rate / counts per second	500	375	280	210	160

What is the half-life of the isotope?

- A** between 0 and 1 hour
- B** between 1 hour and 2 hours
- C** between 2 hours and 3 hours
- D** between 3 hours and 4 hours

BLANK PAGE

Permission to reproduce items where third-party owned material protected by copyright is included has been sought and cleared where possible. Every reasonable effort has been made by the publisher (UCLES) to trace copyright holders, but if any items requiring clearance have unwittingly been included, the publisher will be pleased to make amends at the earliest possible opportunity.

To avoid the issue of disclosure of answer-related information to candidates, all copyright acknowledgements are reproduced online in the Cambridge International Examinations Copyright Acknowledgements Booklet. This is produced for each series of examinations and is freely available to download at www.cie.org.uk after the live examination series.

Cambridge International Examinations is part of the Cambridge Assessment Group. Cambridge Assessment is the brand name of University of Cambridge Local Examinations Syndicate (UCLES), which is itself a department of the University of Cambridge.